



Patient Warming System Controller Model WC5X User Manual

Manufactured by:

Augustine Temperature Management
6581 City West Parkway
Eden Prairie, MN 55344 USA
TEL 952.465.3500
FAX 952.465.3501
www.hotdogwarming.com

EU Authorized Representative:



EMERGO EUROPE
Prinsessegracht 20
2514 AP The Hague
The Netherlands

TEL (31) (0) 70 345-8570
FAX (31) (0) 70 346-7299

CE
2797

Contents

Introduction.....	3
Device Description.....	3
Indications for Use.....	3
Contraindications.....	3
Warnings.....	4
Cautions.....	4
Precautions.....	4
Proper Use and Maintenance.....	6
Initial Setup & Assembly.....	6
Contents.....	6
Mounting the HotDog Controller to an IV Pole.....	7
Control Panel Features & Operating Modes.....	8
Alarms.....	10
Error Codes.....	10
Instructions for Use.....	11
Maintenance & Cleaning.....	12
Testing of Indicator Light Function.....	12
Cleaning—General.....	12
Cleaning—Controller.....	13
Cleaning—Warming Devices.....	13
Technical Support & Customer Service.....	16
Definition of Product Symbols.....	17
Accessory Part Numbers.....	17
Specifications.....	18
Electromagnetic Compatibility (EMC).....	20

INTRODUCTION

Device Description

The HotDog Patient Warming System consists of the HotDog Controller, reusable warming devices (e.g., Warming Blankets, Warming Mattresses) and accessories. This manual includes use and maintenance instructions and specifications for the HotDog Controller Model WC5X. For information about HotDog warming devices and accessories, refer to the User Manual provided with each device/accessory.

The HotDog Controller is designed to help maintain normothermia in patients before, during and after surgical procedures and to help prevent unintended hypothermia. The system is powered and controlled by an electronic control unit. Warming devices are powered at low voltage, ensuring safety for patients and operators. Warming temperatures are controlled automatically to user-selected levels, and over-temperature safety shut-offs are integrated into the controller as well as into each warming device.

The HotDog Controller can be placed on a flat surface, mounted on an IV pole or suspended from the OR table/gurney rail using optional hooks. The HotDog Patient Warming System can be operated continuously to maintain uniform heat under or over the patient, depending on which warming device/accessory is selected. It is the responsibility of the user to determine whether warming is appropriate for each individual patient. The HotDog Patient Warming System should not be used when clinical considerations indicate that warming of the patient is not advisable.

Indications for Use

The HotDog Patient Warming System is intended to prevent or treat hypothermia and to provide warmth to patients. The HotDog Patient Warming System should be used in circumstances in which patients may not maintain a state of normothermia. The System is intended primarily for use in hospitals and surgical centers including, without limitation, operating, recovery, and emergency rooms and on medical/surgical floors.

Contraindications

- DO NOT warm ischemic or non-perfused tissue; thermal injury may result. Examples include tissue distal to aortic cross clamping, or when vasoconstrictive drugs would lead to severe, prolonged vasoconstriction.
- DO NOT warm patients receiving transdermal medication; increased drug delivery may occur.

WARNINGS

General

- **EXPLOSION HAZARD – DO NOT** use the HotDog Patient Warming System in the presence of flammable anesthetics or highly oxygen-enriched environments such as hyperbaric chambers, oxygen tents, etc.
- **Inspect HotDog components prior to use** for signs of damage or excessive wear such as cuts, holes or loose electrical connections. If signs of wear are evident, do not use the product until it is inspected by technical staff.
- **DO NOT** continue to use the HotDog Patient Warming System if the over temperature indicator and/or alarm continue to sound after reset. Refer to the “Alarm” section of this manual for more information.

Warming Blanket

- **DO NOT** place HotDog Warming Blankets under the patient. The Warming Mattress and Disposable Sheets are the only accessories designed for use under the patient.

Warming Mattress

- The Warming Mattress is not sterile. Take appropriate precautions, as necessary, to protect the sterile field.

Accessories and Other Equipment

- Accessories and cables other than those specified in HotDog User Manuals may result in increased emissions or decreased immunity of the HotDog Patient Warming system.
- The HotDog Patient Warming System should not be used adjacent to or stacked with other equipment. If adjacent or stacked use is necessary, carefully observe the HotDog Patient Warming System to verify that it operates normally in this non-recommended configuration.

CAUTIONS

Federal law (USA) restricts this device to sale by or on the order of a licensed healthcare professional.

PRECAUTIONS

General

- Use under the direct supervision of a clinician.
- Monitor the patient’s vital signs regularly during warming according to institutional protocol. If vital sign instability occurs, notify the clinician.
- Care should be taken when using multiple warming methods.

- Dispose of the Controller per local regulations. Follow Warming Blanket and Mattress User Manuals for proper disposal.
- The risk of skin irritation caused by pooling of surgical prep solutions under the patient may increase with warming; ensure that surgical prep solution instructions for use are followed.

Warming Mattress

- Ensure that the Warming Mattress is securely fastened to the table.
- The use of gel pads between the Warming Mattress and the patient is not recommended; gel pads may cause a loss of warming performance.
- Always use a thin patient barrier between the patient and the Warming Mattress.
- Maintain contact between the patient and the labeled sensor on the Warming Mattress.
- DO NOT use operating table clamps or similar devices on the Warming Mattress as they may cause damage to the product and result in loss of the heating function and/or localized heat build-up in the damaged area.
- DO NOT place the Warming Mattress over a table joint that will move during surgery.
- DO NOT use the Warming Mattress as a stand-alone patient pressure relief system.
- DO NOT place any hard objects (e.g., mattress cables, EKG cables, hard cautery return pads, patient fluid lines, etc.) between the Warming Mattress and patient's body.
- DO NOT fold or wrinkle the Warming Mattress during use as localized heat build-up may occur in the overlapped area.
- DO NOT use the Warming Mattress when the risk of pressure injury cannot be mitigated
- Adjust placement of the Warming Mattress during X-rays as the internal wiring, located primarily along the edges of the device, and the sensor with associated wire may appear in the images.
- DO NOT allow patient fluid lines to be placed between the Warming Mattress and Warming Blanket or other warming equipment.
- DO NOT position the patient's head directly on the Warming Mattress.

PROPER USE AND MAINTENANCE

- **DO NOT** continue to use the HotDog Patient Warming Blanket beyond the labeled expiration date
- **DO NOT** continue to use the HotDog Patient Warming Mattress beyond the labeled expiration date

Do not open the HotDog Controller. There are no user serviceable parts. If service is required, contact Technical Support (see **page 17**). The manufacturer assumes no responsibility for the reliability, performance, or safety of the HotDog Patient Warming System if the following events occur:

- The Controller is disassembled or serviced by an unauthorized person.
- The Patient Warming System components are used in a manner other than described in the User Manuals.
- The Controller is installed in an environment that does not meet the appropriate electrical and grounding requirements.
- The Controller is grounded and should not be attached to an un-grounded table intended for use with a hyfreicator or equivalent devices.

INITIAL SETUP & ASSEMBLY

Contents

The following components are included in the HotDog Controller box:

- 1—HotDog Controller Model WC5X
- 1—IV pole adapter and mounting hardware
- 1—Mains power cord
- 1—CD containing User Manual and Service Manual
- 1—HotDog Warming Blanket Cable (P/N A101)

Reusable HotDog accessories (e.g., Warming Blankets, Warming Mattresses, connecting cables, OR table/gurney rail hooks) and HotDog Disposable Sheets are sold separately.

Mounting the HotDog Controller to an IV Pole

To mount the HotDog Controller to an IV pole, place the Controller IV pole adapter around the IV pole and turn the clamp handle clockwise until securely tightened (**Figure 1**). To remove the Controller from the IV pole, turn the clamp handle counterclockwise until the unit releases.

Caution

To prevent the IV pole from tipping, the Controller must be attached at a height that provides stability. It is recommended to use an IV pole with a minimum wheelbase radius of 35.6 cm (14 in) and to mount the Controller no higher than 112 cm (44 in) from the floor. Failure to properly mount the Controller may result in IV pole tipping, catheter site trauma and patient injury.

Figure 1: HotDog Controller Mounted on an IV Pole

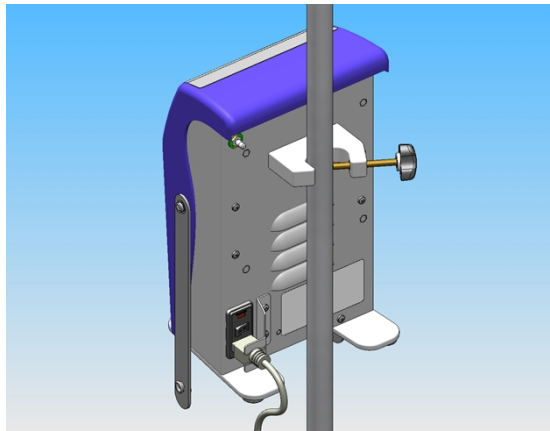

The Controller may also be suspended from the OR table/gurney rail using optional hooks (**Figure 2**).

Figure 2: Optional OR Table/Gurney Rail Hooks

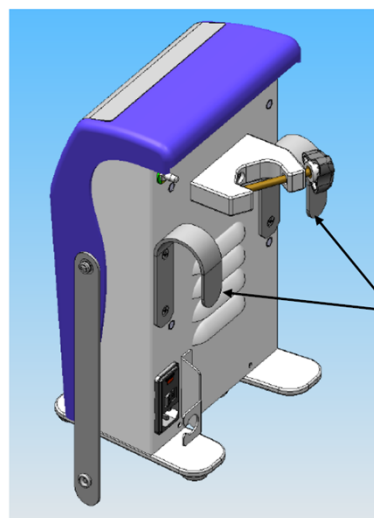

The Controller may be suspended from the OR table/gurney rail using these optional hooks

(Note: Hook location may vary depending on model)

Control Panel Features & Operating Modes

Figure 3: HotDog Model WC5X Controls

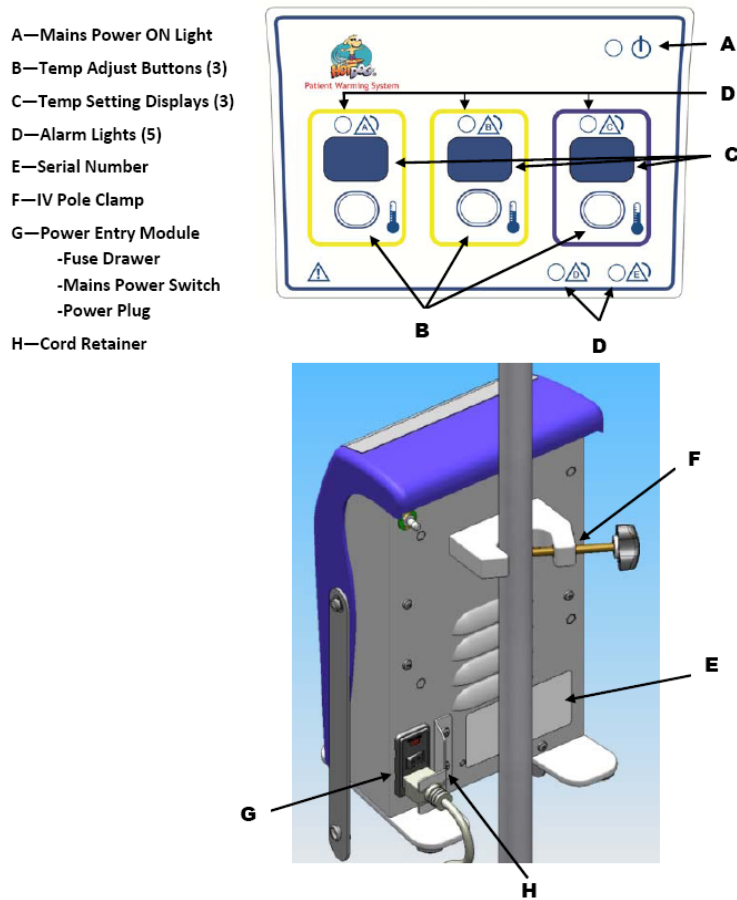
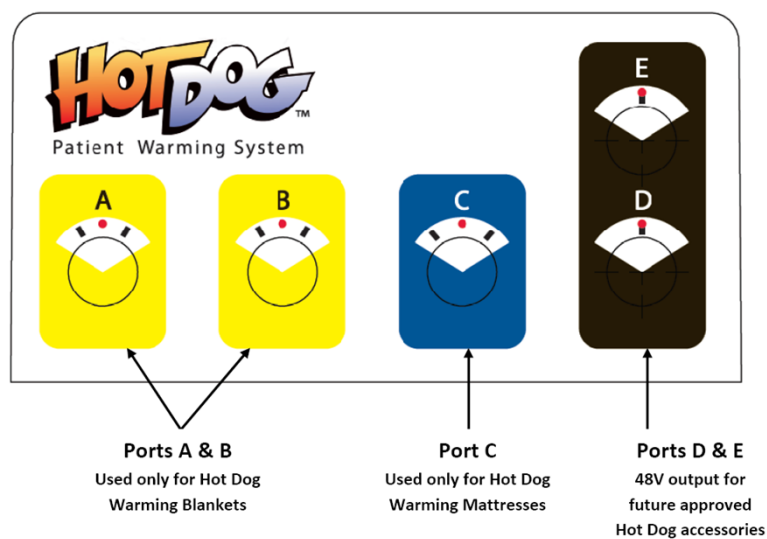

Figure 4: HotDog Ports



Mains Power Switch / ON Power Indicator

When the HotDog Controller is plugged into an electrical outlet and the Mains Power Switch on the back of the Controller is turned ON, all displays will illuminate briefly and the

Controller will beep. Afterwards, the software version is displayed for approximately 2 seconds. The Mains Power ON Light will illuminate and the Controller will remain idle until a warming device is plugged in. When the unit is ON and idle (i.e., no Temperature Setting Lights are illuminated), no power is applied to the warming device and no alarm conditions are indicated.

Temperature Adjust Button / Temperature Setting Display

When a warming device is plugged into a port, an audible beep will sound and the display will show two dashes. Press the Temperature Adjust Button for the desired port until the desired temperature is displayed. The temperature can be selected in one degree increments from 37-43°C for Ports A and B (Warming Blankets) and 35-39°C for Port C (Warming Mattresses). The designated warming temperature will flash until the selected temperature is achieved, at which time the selected temperature will steadily display.

Port A, B and C

Ports A and B are used only for HotDog Warming Blankets, and Port C is used only for HotDog Warming Mattresses. When a warming device is plugged into the Controller, an audible beep indicates that the control and over temperature sensors are present and functioning properly.

Port D and E

Ports D and E supply a 48V output for future approved HotDog accessories; at this time there are no accessories manufactured for use on these ports.

Alarms

Alarm: Port A, B and C

If the warming device sensor temperature exceeds one degree above set point or other fault conditions exist, an audible alarm sounds and the Alarm Light for the affected port illuminates Yellow. The Controller will automatically turn off power to that warming device. If the Alarm Light stays illuminated and the alarm continues to sound, disconnect the warming device from the Controller to silence the alarm. If the controller alarms again after a reset was performed, discontinue use and refer the Controller to biomedical engineering for evaluation.

Error Codes

The Controller displays the following error codes on the Temperature Display for specific alarm conditions. Refer to Troubleshooting and Error Codes sections for more details.

Error Code	Alarm Condition
E1 on affected port	Over-temperature alarm – Temperature of sensor has exceeded 1 degree above set-point
E2 on affected port	Time-to-temperature alarm – device has not reached selected set point within ten minutes
E3 on affected port	Over-current condition
E3 on all ports	System over-current condition
E4 on affected port	Primary or secondary broken sensor alarm
E5 on affected port	Over-temperature array alarm
E8 on affected port	Over temperature – Secondary – Temperature of sensor has exceeded 46C for blankets and 41.5 C for mattresses (on controllers with software version 1.06 and lower, this alarm displays as E1 and not E8)
Six hour timer	If a warming device is left on with no adjustment to temperature settings for six hours the controller will turn off power to warming device.
EA, EC, EE, EF, EH, EP on all ports	System failure, refer controller to biomedical engineering department.

INSTRUCTIONS FOR USE

The instructions below describe how to operate the Model WC5X Controller. For information about HotDog warming devices and accessories, refer to the User Manual provided with each device/accessory.

1. Mount the HotDog Controller on an IV pole or the OR table/gurney rail (refer to **page 7**), or place the device on a flat, horizontal surface.
2. Insert the HotDog Controller power plug into a properly grounded hospital grade electrical outlet.

WARNING: To avoid risk of electric shock, this equipment must only be connected to a supply mains with protective earth grounding.

Note: The Controller is grounded and should not be attached to un-grounded tables intended for use with a hyfrecator or equivalent devices.

3. After the lights illuminate in sequence, the unit will emit an audible tone and display the software revision on the Temp Setting Display for approximately 2 seconds.
4. Position and secure the HotDog warming device (e.g., Warming Blanket, Warming Mattress) **following instructions in the User Manual provided with the device.**
5. Insert the warming device connecting cable into the proper port on the Controller.

Controller Port	Warming Device
A and B	Warming Blanket
C	Warming Mattress
D and E	Future approved HotDog accessories

Note: When the connecting cable is inserted into the Controller, an audible beep indicates that the control sensor and over temperature thermistor are present and functioning properly.

6. Press the Temp Adjust Button that corresponds with the port being used until the desired temperature is set, as indicated by the Temp Setting Display. The display will flash until the temperature has been reached.
7. Monitor the patient's temperature regularly. Adjust the temperature setting of the HotDog Controller as necessary to maintain the desired patient temperature.
8. When patient warming therapy is complete, turn the Mains Power Switch to OFF.
9. After use, disconnect the HotDog Controller from the electrical outlet.
10. Discard disposable accessories following standard hospital procedure. Clean the reusable warming device as instructed in the User Manual provided with the device.

MAINTENANCE & CLEANING

Testing of Indicator Light Function

Frequency

This test should be completed upon initial equipment check-in and once every 12 months (or more frequently if required by hospital guidelines).

Method

1. Insert the HotDog Controller power plug into a properly grounded hospital grade electrical outlet and confirm that NO cables or devices are connected to any of the ports.
2. Turn the Mains Power Switch to ON and observe for the following proper start-up sequence:
 - a. Individual Alarm lights power up sequentially
 - b. Segmented displays power up as individual units (sequentially, left to right)
3. After the lights illuminate in sequence, the software version is displayed for approximately 2 seconds.
4. After the sequence completes, only the Mains Power ON Light remains illuminated.
5. If this sequence varies or is incomplete, contact Technical Support (see **page 17**).

Cleaning—General

Warnings

- DO NOT use a dripping wet cloth and DO NOT immerse HotDog components in liquid. Moisture will damage the components, and thermal injury may result.

Precautions

- DO NOT use pure harsh solvents (e.g., MEK, acetone, etc.) to clean HotDog components. Solvents may damage plastic parts, labeling and product finish.
- DO NOT use high-level disinfectants (e.g., glutaraldehyde, peracetic acid or hydrogen peroxide-based solutions). The U.S. Centers for Disease Control (CDC) recommends against the use of high level disinfectants for cleaning environmental surfaces that may contact the patient since the chemicals are highly toxic.
- DO NOT spray cleaning solutions into electrical connectors.

Recommended cleaners

Alcohol-based disinfectants are easiest to use since they are fast-acting and can be either sprayed or wiped on. The following list of alcohol-based cleaners is provided for reference only and is not an endorsement of the manufacturers or their cleaning products: Ecolab (Incidin Liquid, Incides N, Incidin Foam, Incidin Sun, Mikro-Bak III), Merz (Pursept-A Xpress, Pursept Foam, Mucocit-A Economy) and Lysoform (Aerodesin 2000, Lysoform Spray).

Other cleaners that have been tested and are compatible with the outer surfaces of HotDog components include sodium hypochlorite (diluted bleach), phenolic germicidal detergent quaternary ammonium detergent.

Cleaners that contain iodine may cause surface discoloration and are therefore NOT recommended for routine cleaning.

Cleaning—Controller

Frequency

As needed

Tools/Equipment

- Sponge or soft cloth
- Mild detergent or anti-microbial spray
- Dry soft cloth

Method

1. Disconnect the Controller from the power source before cleaning.
2. Wipe unit with moistened sponge or soft cloth; avoid pushing fluids into any openings.
3. Dry with a separate soft cloth.

Cleaning—Warming Devices

Frequency

Clean between patient use and when the warming device appears soiled.

Method

Clean the warming devices following protocols for non-critical medical devices that may contact intact skin. Examples of similar devices are blood pressure cuffs, exam table covers, operating room table pads and surgical supports. **Cleaning steps are described in the User Manual provided with the warming device.** Note that the cleaning instructions are general recommendations and are not meant to replace hospital-specific cleaning protocols.

TROUBLESHOOTING/ERROR CODES

Alarm lights and error code display

Alarm lights and an audible alarm turn on when an error condition occurs. The associated error code will remain on the display until the condition is cleared. If multiple alarm conditions occur sequentially, the code associated with the initial alarm condition will be displayed. In all cases, the heater is turned off when an alarm occurs.

Alarm Error Condition	Error Code Displayed	Description
Over-temperature (primary)	E1 (for each port)	When the temperature exceeds one degree above set point, audible and visual alarms are initiated, and power is removed from the output. The alarm will reset when: <ul style="list-style-type: none"> • Temperature is within acceptable limits ($\pm 1^{\circ}\text{C}$), or • Cable connecting warming device to Controller is disconnected, or power is turned off at mains switch.
Heater Time Out	E2 (for each port)	Failure to reach temp (Time to Temperature): When the system does not achieve the set-point within 10 minutes, audible and visual alarms are initiated. The alarm will reset when the device is unplugged or power is turned off at mains switch.
Overcurrent (Port)	E3 (for each port)	When port current draw exceeds a predetermined level, audible and visual alarms are initiated. The alarm will reset when the device is unplugged or power is turned off at mains switch.
Primary or Secondary sensor failure	E4 (for each port)	Sensor are reading outside of the useful range
Fold detection alarm	E5 (for each port)	In warming devices equipped with an over-temperature array, local overheating caused by folding of the warming blanket will initiate visual and audible alarms. The alarm will reset when the device is unplugged or power is turned off at mains switch.
Over-temperature (secondary)	E8 (for each port) for software versions ≥ 1.07 E1 for software version ≤ 1.06	When the temperature exceeds 46°C on port A and B or 41.5 on Port C, audible and visual alarms are initiated. The alarm will reset when the device is unplugged or power is turned off at mains switch.
Temperature control timeout	-- (for each port)	If a warming device is left operating for 6 hours with no changes to set point, power will be removed, three short audible chirps will sound, and the visual alarm indicators will flash continuously. Pressing the temperature select button will clear the alarm and re-start normal operation.
Overcurrent (System)	E3, E3, E3	Too many large heating devices in use. Power system down (remove from mains or cycle power switch). Remove one device and re-start. If problem continues call customer service
Calibration failure	EA, EA, EA	System failure. If this occurs, call customer service for technical support
Hardware CPLD failure	EC, EC, EC	System failure. If this occurs, call customer service for technical support































System Failure (FET Failure)	EF, EF, EF	System failure. If this occurs, call customer service for technical support
Hardware I2C failure	EH, EH, EH	System failure. If this occurs, call customer service for technical support
Hardware power supply failure	EP, EP, EP	System failure. If this occurs, call customer service for technical support
General System Failure	EE, EE, EE (software version 1.06 or lower only)	System failure. If this occurs, call customer service for technical support

TECHNICAL SUPPORT & CUSTOMER SERVICE

Please have the serial number of your HotDog Controller when you call for technical support. The serial number is located on the back of the Controller. If it is necessary to return the Controller for service or repair, contact your local supplier or sales representative.

Augustine Temperature Management
6581 City West Parkway
Eden Prairie, MN 55344 USA
TEL 952.465.3500
FAX 952.465.3501
www.hotdogwarming.com

DEFINITION OF PRODUCT SYMBOLS

	Do Not Place Under Patient		This Side Up		Mains Power On Indicator
	This Side Down		Heating Area		Alarm
	Attention, consult accompanying documents		Reference Number		Lot Number
	BF Patient Applied Part according to IEC60601-1.		Serial Number		Manufacture Date
	Temperature in Range		Transport and storage temperature range		Temperature Adjustment
	Keep Dry		Transport and storage humidity range		Fuse
	Equipotential		Medical Device restricted to sale by or on the order of a physician		Return to Authorized Representative
	Temperature Sensor		Do not use after YYYY-MM-DD		Manufacturer
	See IFU for Warnings		Medical Device		See electronic IFU on website at URL provided
	EU Authorized Representative				
IPX2	Protected against dripping water when tilted up to 15°; Vertically dripping water shall have no harmful effect when the enclosure is tilted at an angle up to 15° from its normal position.				
	Conforms to European Medical Device Directive 93/42/EEC				
	Medical Equipment Classified by Intertek Testing Services NA Inc. with respect to electric shock, fire, and mechanical hazards only, in accordance with UL 60601-1. Classified under the Medical Device Directive (93/42/EEC) as a Class IIb device.				

ACCESSORY PART NUMBERS

The following cable part numbers are used with the HotDog Patient Warming System:

Part Number	Description
A101	HotDog Warming Blanket Cable, 4m (13ft)
A112	HotDog Mattress Cable, 4m (13ft)

SPECIFICATIONS

Physical Characteristics									
Dimensions	33 cm high x 14.0 cm deep x 19.7 cm wide 13" high x 5.5" deep x 7.75" wide								
Weight	5 kg (11 lbs)								
Mounting	Can be placed on a horizontal flat surface (i.e. table top), clamped to an IV pole or hung on a OR/gurney rail using optional hanging hooks								
Temperature Characteristics									
Temperature Control	Micro-processor								
Operating Temperatures	Blanket Ports A and B adjustable in 1°C increments 37° to 43° ± 1.0°C 98.6° to 109.4° ± 1.8°F								
	Mattress Port C adjustable in 1°C increments 35° to 39° ± 1.0°C 95° to 102.2° ± 1.8°F								
Safety System									
All alarm conditions are classified as Medium Priority Technical Alarms									
Auditory Alarms	Minimum SPL of 65 dB(A) at 3m (from front of controller) with a back ground SPL not to exceed 55dB(A)								
Primary Over-temp Alarm	Ports A and B (Warming Blanket) Alarm sounds when temperature sensor is at set point + 1°C								
	Port C (Warming Mattress) Alarm sounds when temperature sensor at set point + 1°C								
Secondary Over-temp Alarm	Ports A and B (Warming Blanket) Independent electronic circuit shuts the heater off if the Warming Blanket temperature sensor reaches set point + 3°C. (46°C) Port C (Warming Mattress) Independent electronic circuit shuts the heater off if the Warming Mattress temperature sensor reaches set point ± 2.5°C (41.5°C)								
Time to reach temperature from 23 C +/- 2 C	Less than 10 minutes								
Time out timer	If warming device does not reach set temperature within 10 minutes the controller will alarm								
Six hour timer	If a warming device is left at a steady setting for six hours the controller will discontinue power to warming device.								
Over-current limits	<table border="1"> <tr> <td>Port A</td> <td>10 amps max</td> </tr> <tr> <td>Port B</td> <td>10 amps max</td> </tr> <tr> <td>Port C</td> <td>5 amps</td> </tr> <tr> <td>System</td> <td>14.6 amps</td> </tr> </table>	Port A	10 amps max	Port B	10 amps max	Port C	5 amps	System	14.6 amps
Port A	10 amps max								
Port B	10 amps max								
Port C	5 amps								
System	14.6 amps								
System Over-current Protection	Dual input fused lines.								
Electrical Characteristics									
Leakage Current	Meets UL 60601-1 and IEC 60601-1 requirements for Class I, Type BF equipment.								
Power Consumption	850W maximum								

Power Cord	4.6 m (15 ft) - May vary by country and region per local requirements and regulations.
Device Ratings	Input: 100-240 VAC, 50/60 Hz, 850VA Output A & B: 48 VDC, 480 VA Max each Output C: 240 VA Max Output D & E: 48 VDC, 144 VA Max each
Fuses	T10AL250V (2 x 5x20mm)
Environmental Conditions	
Environmental Conditions for Transport and Storage	Temperature: -20°C to 60°C Humidity: 20% to 80% Keep Dry
Environmental Conditions for Use	Temperature: 15°C to 25°C Humidity: 20% to 80%
Classification and Standards	
Certifications	IEC 60601-1; EN 60601-1-2; UL 60601-1; CAN/CSA-C22.2, No. 601.1, EN 55011 
Classification	Classified under IEC 60601-1 Guidelines (and other national versions of the Guidelines) as Class I, Type BF, Ordinary equipment, Continuous operation. Not suitable for use in presence of flammable anesthetic mixtures with air or with oxygen or nitrous oxide. Classified by Intertek Testing Services NA Inc. with respect to electric shock, fire, and mechanical hazards only, in accordance with UL 60601-1. Classified under the Medical Device Directive (93/42/EEC) as a Class IIb device. Classified under the Canadian Medical Device Regulation as Class II.
Diagnostics	A qualified technician can perform general system testing. The Controller has no user serviceable parts.
Important Information	This device complies with the EMC requirements according to IEC 60601-1-2. Radio transmitting equipment, cellular phones, etc. shall not be used in the close proximity of the device since this could influence the performances of the device. Particular precaution must be considered during use of strong emission sources such as High Frequency surgical equipment and similar so that, e.g., the HF-cables are not routed on or near the device. If in doubt, contact a qualified technician or your local representative.

ELECTROMAGNETIC COMPATIBILITY (EMC)

The HotDog Patient Warming System requires special precautions regarding EMC and must be installed and put into service according to the EMC information provided in this User Manual.

Warning

- **Use of accessories and cables other than those specified may result in increased emissions or decreased immunity of the HotDog Patient Warming System.**
- **The HotDog Patient Warming System should not be used adjacent to or stacked with other equipment. If adjacent or stacked use is necessary, carefully observe the HotDog Patient Warming System to verify that it operates normally in this configuration.**

Guidance and Manufacturer's Declaration – Electromagnetic Emissions		
The HotDog™ Patient Warming System is intended for use in the electromagnetic environment specified below. The customer or user of the HotDog Patient Warming System should assure that it is used in such an environment.		
Emissions test	Compliance	Electromagnetic Environment – Guidance
RF emissions, CISPR 11	Group 1	The HotDog Patient Warming System uses RF energy only for its internal function. Therefore, its RF emissions are very low and are not likely to cause any interference in nearby electronic equipment.
RF emissions, CISPR 11	Class A	The HotDog Patient Warming System is suitable for use in all establishments other than domestic and those directly connected to the public low-voltage power supply network that supplies buildings used for domestic purposes.
Harmonic emissions, IEC 61000-3-2	Class A	
Voltage fluctuations/ flicker emissions, IEC 61000-3-3	Complies	

Guidance and Manufacturer's Declaration – Electromagnetic Immunity			
The HotDog™ Patient Warming System is intended for use in the electromagnetic environment specified below. The customer or the user of the HotDog Patient Warming System should assure that it is used in such an environment.			
Immunity Test	IEC 60601 Test Level	Compliance Level	Electromagnetic Environment – Guidance
Electrostatic discharge (ESD) IEC 61000-4-2	±6 kV contact ±8 kV air	±6 kV contact ±8 kV air	Floors should be wood, concrete or ceramic tile. If floors are covered with synthetic material, the relative humidity should be at least 30 %.
Electrical fast transient/burst IEC 61000-4-4	±2 kV for power supply lines ±1 kV for input/output lines	±2 kV for power supply lines ±1 kV for input/output lines	Mains power quality should be that of a typical commercial or hospital environment.
Surge IEC 61000-4-5	±1 kV line(s) to line(s) ±2 kV line(s) to earth	±1 kV line(s) to line(s) ±2 kV line(s) to earth	Mains power quality should be that of a typical commercial or hospital environment.
Voltage dips, short interruptions and voltage variations on power supply input lines IEC 61000-4-11	<5 % <i>UT</i> (>95 % dip in <i>UT</i>) for 0,5 cycle 40 % <i>UT</i> (60 % dip in <i>UT</i>) for 5 cycles 70 % <i>UT</i> (30 % dip in <i>UT</i>) for 25 cycles <5 % <i>UT</i> (>95 % dip in <i>UT</i>) for 5 sec	<5 % <i>UT</i> (>95 % dip in <i>UT</i>) for 0,5 cycle 40 % <i>UT</i> (60 % dip in <i>UT</i>) for 5 cycles 70 % <i>UT</i> (30 % dip in <i>UT</i>) for 25 cycles <5 % <i>UT</i> (>95 % dip in <i>UT</i>) for 5 sec	Mains power quality should be that of a typical commercial or hospital environment. If the user of the HotDog Patient Warming System requires continued operation during power mains interruptions, it is recommended that the HotDog Patient Warming System be powered from an uninterruptible power supply or a battery.
Power frequency 50/60 Hz) magnetic field IEC 61000-4-8	3 A/m	3 A/m	Power frequency magnetic fields should be at levels characteristic of a typical location in a typical commercial or hospital environment.
NOTE <i>UT</i> is the a.c. mains voltage prior to application of the test level.			

Guidance and Manufacturer’s Declaration – Electromagnetic Immunity (cont’d)			
The HotDog™ Patient Warming System is intended for use in the electromagnetic environment specified below. The customer or the user of the HotDog Patient Warming System should assure that it is used in such an environment.			
Immunity Test	IEC 60601 Test Level	Compliance Level	Electromagnetic Environment – Guidance
<p>Conducted RF IEC 61000-4-6</p> <p>Radiated RF IEC 61000-4-3</p>	<p>3 Vrms 150 kHz to 80 MHz</p> <p>10 V/m 80 MHz to 2,5 GHz</p>	<p>3 V</p> <p>10 V/m</p>	<p>Portable and mobile RF communications equipment should be used no closer to any part of the HotDog Patient Warming System, including cables, than the recommended separation distance calculated from the equation applicable to the frequency of the transmitter.</p> <p>Recommended separation distance</p> $d = 1,2\sqrt{P}$ $d = 0,35\sqrt{P} \quad 80 \text{ MHz to } 800 \text{ MHz}$ $d = 0,7\sqrt{P} \quad 800 \text{ MHz to } 2,5 \text{ GHz}$ <p>where P is the maximum output power rating of the transmitter in watts (W) according to the transmitter manufacturer and d is the recommended separation distance in metres (m). Field strengths from fixed RF transmitters, as determined by an electromagnetic site survey,^a should be less than the compliance level in each frequency range.^b</p> <p>Interference may occur in the vicinity of equipment marked with the following symbol:</p> 
NOTE 1 At 80 MHz and 800 MHz, the higher frequency range applies.			
NOTE 2 These guidelines may not apply in all situations. Electromagnetic propagation is affected by absorption and reflection from structures, objects and people.			
<p>^a Field strengths from fixed transmitters, such as base stations for radio (cellular/cordless) telephones and land mobile radios, amateur radio, AM and FM radio broadcast and TV broadcast cannot be predicted theoretically with accuracy. To assess the electromagnetic environment due to fixed RF transmitters, an electromagnetic site survey should be considered. If the measured field strength in the location in which the HotDog Patient Warming System is used exceeds the applicable RF compliance level above, the HotDog Patient Warming System should be observed to verify normal operation. If abnormal performance is observed, additional measures may be necessary, such as reorienting or relocating the HotDog Patient Warming System.</p> <p>^b Over the frequency range 150 kHz to 80 MHz, field strengths should be less than 3 V/m.</p>			

Recommended separation distances between portable and mobile RF communications equipment and the HotDog Patient Warming System			
<p>The HotDog™ Patient Warming System is intended for use in an electromagnetic environment in which radiated RF disturbances are controlled. The customer or the user of the HotDog Patient Warming System can help prevent electromagnetic interference by maintaining a minimum distance between portable and mobile RF communications equipment (transmitters) and the HotDog Patient Warming System as recommended below, according to the maximum output power of the communications equipment.</p>			
Rated maximum output power of transmitter W	Separation distance according to frequency of transmitter m		
	150 kHz to 80 MHz $d = 1,2\sqrt{P}$	80 MHz to 800 MHz $d = 0,35\sqrt{P}$	800 MHz to 2,5 GHz $d = 0,7\sqrt{P}$
0,01	0,12	0,04	0,07
0,1	0,37	0,11	0,22
1	1,2	0,35	0,70
10	3,7	1,1	2,2
100	12	3,5	7,0
<p>For transmitters rated at a maximum output power not listed above, the recommended separation distance d in metres (m) can be estimated using the equation applicable to the frequency of the transmitter, where P is the maximum output power rating of the transmitter in watts (W) according to the transmitter manufacturer.</p> <p>NOTE 1 At 80 MHz and 800 MHz, the separation distance for the higher frequency range applies.</p> <p>NOTE 2 These guidelines may not apply in all situations. Electromagnetic propagation is affected by absorption and reflection from structures, objects and people.</p>			

HotDog is a trademark of Augustine Temperature Management, registered in the U.S. Patent & Trademark Office. Patents pending.

© 2020 Augustine Temperature Management. All rights reserved.

P/N 2135EU Revision N (11/2020)